

InverECO - Specifications

TECHNICAL PARAMETER

Model	Advised pool volume (m ³)	P1 (kW)	Voltage (V/Hz)	Current (A)	Qmax (m ³ /h)	Hmax (m)	Circulation Flow (m ³ /h)	
							8m	10m
DE10	20-30	0.50	220-240 50/60	2.3	20.0	14.0	11.5	9.0
DE15	20-40	0.66		2.9	21.0	15.0	15.0	11.0
DE19	30-50	0.80		3.6	23.5	17.0	19.0	14.5
DE23	40-70	1.10		5.0	27.0	19.0	25.0	20.2
DE28	60-90	1.50		6.5	31.0	20.5	30.0	28.0

OVERALL DIMENSION

Model	Packing Dimension (mm)
DE10 / DE15 / DE19 / DE23 / DE28	585*255*325

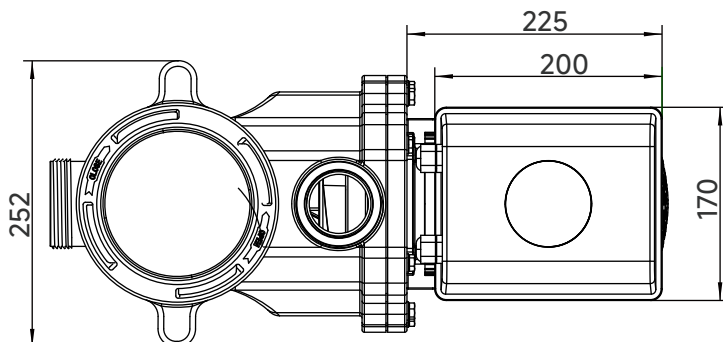
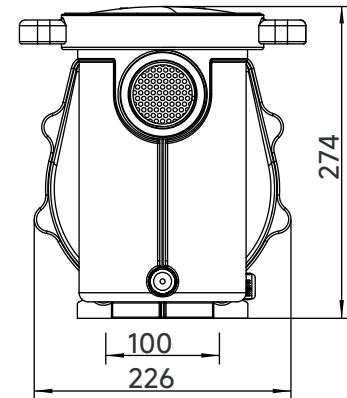
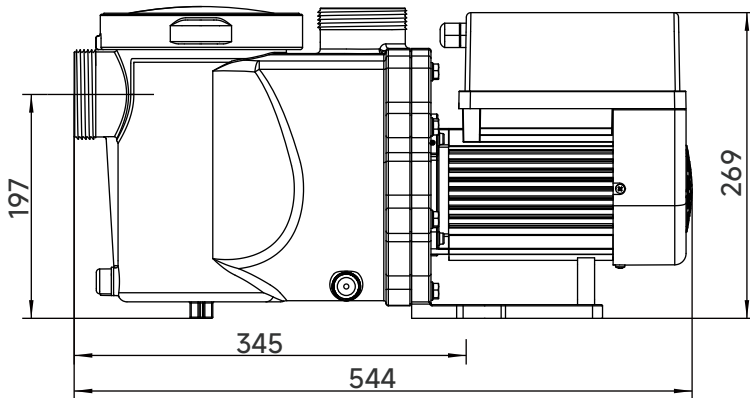

PERFORMANCE CURVE

